

HILTI

**Fastening
Technology Manual**

**Post-Installed
Shear Reinforcement
Hilti HZA-P**



Foreword

A significant number of existing flat slabs requires currently to be strengthened against punching shear for safety reasons (increase of applied loads, deficiencies during design or construction) or to comply with more stringent code requirements. Available strengthening methods are however not completely satisfactory or they cannot be applied in many cases (depending on the possibilities to enlarge column sizes or to intervene on the upper face of slabs). In this document, an innovative system developed by Hilti for strengthening slabs against punching shear and overcoming most of difficulties of existing methods is described. It consists of inclined shear reinforcement installed within existing slabs by drilling holes only from the soffit of the slab and by bonding it with high-performance epoxy adhesive.

Design of the punching shear reinforcement is also treated in the document based on the critical shear crack theory. This theory was developed in Switzerland in the 1980's and is currently the theoretical basis of the Swiss Code for Concrete Structures SIA 262 (2003) with reference to members without shear reinforcement. The theory is based on a physical model allowing to calculate the strength and deformation capacity of members failing in shear or punching shear. An extension of this theory to the shear reinforcing system described in this document was performed at the Swiss Federal Institute of Technology of Lausanne (Switzerland) in cooperation with the scientific consultants of Hilti. This effort resulted into a rather simple and clear design concept accounting for the influence of the many mechanical and geometric parameters of the slabs and shear reinforcement.

The results of the application of the design concept were verified with the experimental results of a test campaign performed by Hilti on 12 full-size slabs. The specimens ($3.0 \times 3.0 \times 0.25$ m) presented different amounts of flexural and shear reinforcement, corresponding to usual cases found in practice. The theory performed very well for predicting both the experimental strength and deformation capacity at failure and with sufficient safety margin. In addition, 6 tests on slabs reproducing real flat slabs with unusual reinforcing or geometric details (steel shearheads, bent-up bars and rectangular columns) were performed. The comparison of such tests to the design model showed again very good results allowing also to reproduce the actual failure modes observed.

The document is finally giving a series of detailing rules to ensure correct performance of the system. Such rules, derived from theoretical considerations, were validated through the test series and avoid developing undesirable failure modes.

Dr. Aurelio Muttoni, Professor at the Swiss Federal Institute of Technology of Lausanne, Switzerland



For further information please contact: jakob.kunz@hilti.com

Content

1 Post-installed punching shear reinforcement	5
1.1 Application range	3
1.2 Advantages of the method	4
2 System description	6
3 Design	7
3.1 Principles	7
3.2 Evaluation of the load to be taken up by the reinforcement	7
3.3 Design of the reinforcement with HZA-P	9
3.4 Punching outside the reinforced area	10
3.5 Rules for good detailing	10
3.5.1 Number of radials	10
3.5.2 Number of reinforcements in a radial	11
3.5.3 Distance between reinforcements and column	11
3.5.4 Radial distance between reinforcements	11
3.5.5 Direction of the drilled holes	11
3.5.6 Length of the drilled holes	11
4 Exbar punching design software	12
5 Examples	13
5.1 Strengthening of a ceiling	13
5.2 Corner column	16
6 Test results	20
7 References	20
8 Installation procedure	21
8.1 Principles	21
8.2 Evaluation of the load to be taken up by the reinforcement	21
8.2.1 Number of radials	21
8.2.2 Number of reinforcements in a radial	22
8.2.3 Number of reinforcements in a radial	22
8.3 Injection preparation	24
8.4 Injection of mortar	25
8.5 Installation of the punching shear reinforcement	26
8.6 Installation of anchor head	27
8.6.1 Injection of the washer with HIT-RE 500	27
8.7 Filling of hole extension with fire protection mortar CP 636	27
9 Materials	28

1 Post-Installed punching shear reinforcement

1.1 Application range

The safety against punching shear of existing concrete slabs is basically determined on the basis of the geometry and the reinforcement of the slab and the column. Such data can be taken from construction drawings if available or they are evaluated in situ by taking out concrete cores and seeking the existing reinforcement.

Post-installed punching shear reinforcement can be applied in two ways: if both the lower and the upper side of the slab are accessible for work simultaneously, then holes can be drilled through the slab. Steel bars can then be introduced through the holes and be prestressed against the slab by tightening nuts on both sides (fig. 1). An appropriate mortar is then injected into the annular gap through an injection washer, e.g. the Hilti Dynamic set. Thus the steel rods cannot move under shear load and water cannot penetrate into the annular gap [1].

Such methods which include working from the upper side of the slab also have certain drawbacks: The cover of the slab has to be removed (earth, tiles, etc...). Moreover the waterproofing system is penetrated and has to be repaired properly after installation of the reinforcement.

As often the upper side is not accessible for work or is accessible only with a high effort, a method has been developed to apply punching shear reinforcement only from the lower side of the slab. Hilti tension anchors HZA-P are bonded into drill holes inclined towards the column by means of an appropriate adhesive mortar (fig. 2). The drilled holes should protrude until at least the level just below the lowest layer of the upper (tensile) reinforcement, but preferably to the centre of the tensile reinforcement. As the effectiveness of punching shear reinforcement strongly depends on the quality of its anchorage, a reliable adhesive mortar is required and the lower anchorage is carried out with the Hilti Dynamic set.

As penetrating reinforcement according to fig. 1 can be designed like cast-in-place punching shear reinforcement on the safe side, this brochure will in the following present details of the post-installed punching shear reinforcement applied only from the lower side of the slab according to figure 2.

1.2 Advantages of the method

- cost effective reinforcement against punching shear loads
- design according to applicable structural concrete code
- proof of safety level required by structural code
- can be combined with cast-in-place punching shear reinforcement
- simple and fast design with software EXBAR-Punching
- fire protection by covered anchorage
- concrete surface remains smooth

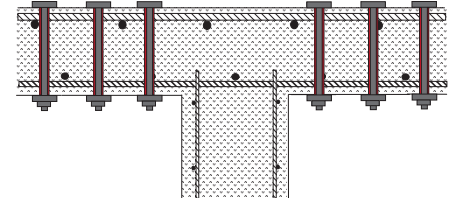

Fig. 1: penetrating post-installed punching shear reinforcement

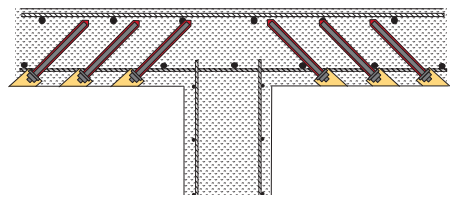

Fig. 2: post-installed punching shear reinforcement applied only from bottom side of the slab



Fig. 3: ceiling reinforcement



Fig. 4: column foundation



Fig. 5: bridge deck

2 System description

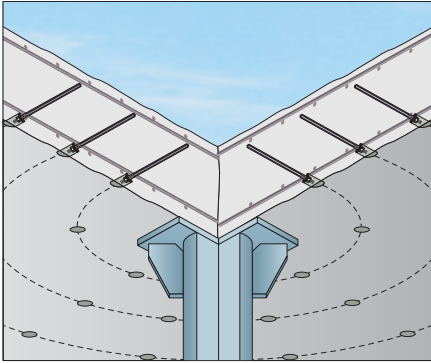

Fig. 6: post-installed punching shear reinforcement



Fig. 7: Hilti tension anchor HZA-P



Fig. 8: anchor head

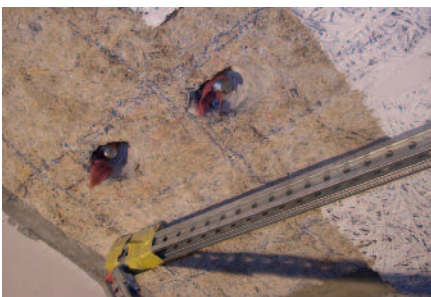

Fig. 9: embedment of anchor head

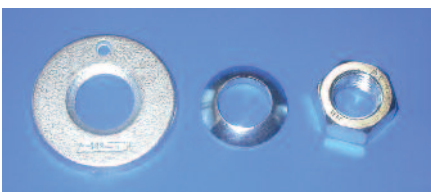

Fig. 10: Hilti Dynamic Set

Hilti Tension Anchors HZA-P in combination with Hilti adhesive mortars are used to install punching shear reinforcement into already hardened concrete slabs.

Inclined holes are hammer drilled into the concrete slab under an angle of 45° and in the direction towards the column. The length of the drilled holes should be such that they reach at least the lowest level of the upper (tensile) reinforcement, but preferably, the holes should end at the level between the tensile reinforcements in the two directions.

Adhesive mortar Hilti HIT-RE 500 is injected into the drilled holes and the Hilti Tension Anchors HZA-P are set into the mortar filled holes. The Hilti tension anchor consists of a reinforcement bar of diameter 16mm or 20mm in the upper part. The lower part is a smooth shaft with a thread M16 or M20 at the end. For the design, the reinforcement bar is decisive since the smooth shaft and thread are made of steel with higher yield strength than that of the reinforcement bar.

After curing of the mortar, the lower anchor head is installed. The Hilti Dynamic Set consists of an injection washer (diameter 52mm for M16 / 60mm for M20), a spherical washer to eliminate bending of the bar and a nut. In order to create a slip-free anchorage the annular gaps are filled through the injection washer with Hilti HIT-RE 500.

The anchor head can be installed on the concrete surface with washers inclined at 45° or be embedded in an enlarged part of the drilled hole. The embedded anchorage has the advantage that it can be covered with a fire protection mortar and is not visible after the installation.

The design method presented in section 3 of this report refers to correctly installed punching shear reinforcement with Hilti Tension Anchors HZA. The appropriate installation equipment and procedure are described in section 8.

3 Design

3.1 Principles

The basis of the design is the punching shear resistance of the existing slab without shear reinforcement, $V_{Rd,c,c}$, which is calculated according to the applicable structural code.

Even if shear reinforcement is provided, the codes usually define a maximum possible punching shear strength ($V_{Rd,max,code}$) accounting for failure of the compression zone of the slab near the column. On the other hand, the specific design concept for reinforcement with Hilti HZA-P also defines a maximum resistance that can be achieved with this method ($V_{Rd,max,HZA-P}$). This value should not be exceeded even if $V_{Rd,max,code}$ is higher.

If the column load V_d is higher than the punching shear resistance of the slab without shear reinforcement, $V_{Rd,c,c}$, then the slab should be strengthened. The design method is based on punching shear tests carried out at the research laboratory of the Hilti Corporation which have been evaluated scientifically at the Federal Institute of Technology in Lausanne, Switzerland (EPFL).

The design model for strengthening with Hilti HZA-P is based on the critical shear crack theory [2] with the following assumptions:

- The punching shear strength of the strengthened slab is the sum of a contribution by the cracked concrete and another contribution by the steel reinforcement:
 $V_{Rd} = V_{Rd,c} + V_{Rd,s}$
- In order to activate the reinforcement, the opening of the shear crack is initiated.
- The opening of the punching shear crack and the maximum aggregate size of the concrete influence the remaining shear resistance of the concrete slab.

In figure 11 the opening of the punching shear crack is represented by the rotation of the slab. The line „Failure Criterion“ shows how the punching shear resistance decreases with increasing rotation of the slab, i.e. with increasing opening of the shear crack.

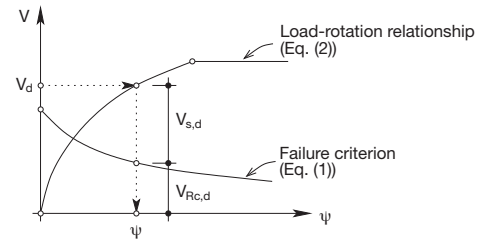

Fig. 11: Load on slab and concrete shear resistance

3.2 Evaluation of the load to be taken up by the reinforcement

The remaining shear strength considering a rotation Ψ_d of the slab is:

$$V_{Rd,c} = \frac{2 \cdot \eta_t \cdot \sqrt{f_{ck}}}{4.5 \cdot \left(1 + 20 \cdot \frac{\Psi_d \cdot d}{d_g + 16} \right)} \cdot d \cdot u' \tag{1}$$

- with:
- $V_{Rd,c}$ concrete contribution to the punching shear resistance [N]
 - η_t factor for long term effects
 (=1.0 if f_{ck} is 28 days design strength; =0.85 if f_{ck} is actual strength)
 - f_{ck} characteristic compressive strength of concrete on cylinder
 150/300 [N/mm²]
 - d_g maximum diameter of concrete aggregates [mm]
 - d effective depth [mm]
 - u' critical section at 0.5d from column edge, see fig. 12 [mm]

The rotation of the slab under load V_d [kN] is evaluated by

$$\psi_d = 1.5 \cdot \frac{r_s}{d} \cdot \frac{f_{yd}}{E_s} \cdot \left(\frac{V_d}{V_{flex}} \right)^{3/2} \quad (2)$$

with:

- r_s distance from column edge to line of contraflexure for bending moments [mm], for regular slabs: $r_s = 0.22 \ell$
- f_{yd} design yield strength of horizontal slab reinforcement [N/mm²]
- E_s Young's modulus of steel (= 205'000N/mm²)
- V_d column load [kN]
- V_{flex} design shear load required to develop flexural strength (plastic mechanism) of the slab [kN]

where $V_{flex} = a \cdot m_{Rd}$ is an approximation of the column force at which the flexural resistance of the slab is reached, where m_{Rd} is the bending resistance of the slab and a is a constant depending on the position of the column. The smallest value of V_{flex} resulting from the different checks has to be considered:

- interior columns: $a = 8 \rightarrow$ check upper reinforcement in both directions
- edge columns: $a = 4 \rightarrow$ check upper reinforcement parallel to edge
 $a = 8 \rightarrow$ check upper and lower reinforcement perpendicular to edge
- corner columns: $a = 2 \rightarrow$ check upper and lower reinforcement in both directions

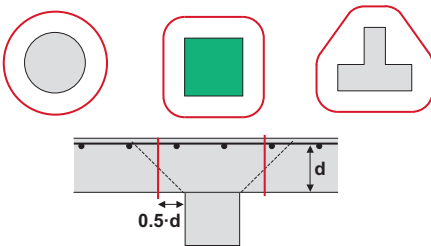

Fig. 12: shear perimeter u_0 for typical column shapes

The design model [2] uses a critical shear perimeter at a distance of 0.5 times the effective depth of the slab d . For standard column shapes, the critical shear perimeter is given in fig. 12. If the slab thickness varies in the vicinity of the column, the shear perimeter resulting in the smallest resistance is critical. The shear perimeter u' will be multiplied by k_e which is a reduction factor taking into account for irregular distribution of the shear force around the column.

$$u' = u_0 \cdot k_e ; k_e = \frac{1}{1 + \frac{e}{b}}$$

If the column connection takes up a bending moment M_d , then the irregular distribution of the shear force is taken into account by $k_e = 1 / (1 + e/b)$ where e is $|M_d/V_d|$ and b is the diameter of a circle with the same area as is inside the critical shear perimeter at 0.5 times the effective depth of the slab. For internal columns with regular spacing $k_e = 0.9$ can be assumed.

Strengthening with Hilti HZA-P is possible if the column load V_d is not higher than the maximum possible resistance of the strengthened slab; $V_{Rd,max,HZA-P}$ is calculated from equation (3) by iterations:

$$V_{Rd,max,HZA-P} = \frac{5.2 \cdot \eta_t \cdot \sqrt{f_{ck}}}{4.5 \cdot \left(1 + 20 \cdot \frac{\psi(V_{Rd,max,HZA-P}) \cdot d}{d_g + 16} \right)} \cdot u' \cdot d \quad (3)$$

$\psi(V_{Rd,max,HZA-P})$ is evaluated with equation (2) using $V_{Rd,max,HZA-P}$ instead of V_d . The shear force which has to be taken up by the strengthening anchors is then:

$$V_{Rd,s,req} = V_d - V_{Rd,c} \geq 0.2 V_d \quad (4)$$

$V_{Rd,c}$ is calculated using the rotation ψ according to formula (2) with parameter V_d .

3.3 Design of the reinforcement with HZA-P

The shear reinforcement is designed to satisfy the following condition:

$$V_{s,d} \leq \sum_{i=1}^n N_{si,d} \cdot \sin \beta_i \cdot k_e \quad (5)$$

where $N_{si,d}$ is the factored strength of the shear reinforcement and β_i is the angle of the shear reinforcement.

The design strength of the Hilti Tension Anchor HZA-P ($N_{si,d}$) is equal to the minimum of the following values:

$$N_{si,d} = \min(N_{si,el,d}; N_{si,pl,d}; N_{si,b,d}; N_{si,p,d}) \quad (6)$$

Where $N_{si,el,d}$ is the force in the shear reinforcement that can be activated assuming an elastic behaviour of the bar. This value, accounting for the rotation of the slab at SLS (see fig. 14) results:

$$N_{si,el,d} = K_{ai} \cdot \sqrt{\Delta\psi_d} \cdot h_i \cdot \sin(\alpha + \beta_i) \quad [MN]; [m] \quad (7)$$

Where α is the angle of the critical shear crack (normally set to 45°). In the standard case of reinforcements set under $\beta_i=45^\circ$ the value of $\sin(\alpha+\beta_i)=1.0$. h_i is the height at which the reinforcement is crossed by the critical shear crack (Fig. 13). $\Delta\psi_d$ is the decisive rotation of the structure to be reinforced: $\Delta\psi_d = \psi_d - \psi_{SLS}$.

V_{SLS} is the column load acting while the strengthening work is carried out. Therefore, equation (2), in the case of interior columns, becomes:

$$\Delta\psi_d = 1.5 \cdot \frac{r_s}{d} \cdot \frac{f_{yd}}{E_s} \cdot \left[\left(\frac{V_d}{8m_{Rd}} \right)^{3/2} - \left(\frac{V_{SLS}}{8m_{Rd}} \right)^{3/2} \right] \quad (\text{example valid for interior columns}) \quad (2a)$$

K_a is a coefficient depending on the anchorage and is given in the following table 1:

	HZA-P M16	HZA-P M20
Hilti HIT-RE 500	$K_{ai} [MN/m^{0.5}] = 2.62 \left(\frac{f_{cc,k} [N/mm^2]}{25} \right)^{0.05}$	$K_{ai} [MN/m^{0.5}] = 3.67 \left(\frac{f_{cc,k} [N/mm^2]}{25} \right)^{0.05}$

Table 1: anchorage factors ($f_{cc,k}$ =characteristic cube strength of concrete)

$N_{si,pl,d}$ is the plastic resistance of the reinforcement bar, its value is:

$$N_{si,pl,d} = A_{si} \cdot f_{yd} \quad (8)$$

$N_{si,b,d}$ is the upper limit of the resistance due to the bond strength. It is assumed that the bar is bonded between the point where it cuts the shear crack and its upper end ($\ell_{b,sup,i}$ see Fig. 13).

$$N_{si,b,d} = \tau_{bd} \cdot d_b \cdot \pi \cdot \ell_{b,sup,i} \quad (9)$$

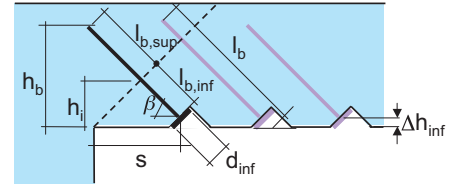

Fig. 13: geometry of reinforcement

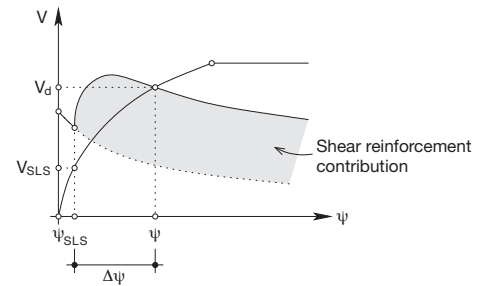

Fig. 14: Definition of $\Delta\psi_d$

The design value of the bond strength is evaluated as $\tau_{bd} = \tau_{bd}^0 \cdot f_{B,N}$, where τ_{bd}^0 is the design strength in a concrete of class C20/25 and $f_{B,N}$ takes into account the effective concrete strength. The values are given in the following table 2. $f_{cc,k}$ should not be considered higher than 60 N/mm².

		Hilti HIT-RE 500
Bond strength:	$\tau_{bd}^0 =$	6.67 N/mm²
Influence of concrete strength:	$f_{B,N} =$	$\left(\frac{f_{cc,k}}{25 \text{ N/mm}^2}\right)^{0.1}$ 25 MPa \leq $f_{cc,k} \leq$ 60MPa

Table 2: bond strength

$N_{si,p,d}$ is the resistance against pullout (by concrete cone failure) of the lower anchorage (Fig. 13):

$$N_{si,p,d} = A_{si} \cdot \frac{0.360}{\gamma_c} \cdot \sqrt{f_{ck}} \cdot \frac{\ell_{b,inf,i}^{1.5}}{d_{bi}^2} \left(1 + \frac{d_{inf,i}}{\ell_{b,inf,i}}\right) \quad [\text{MN}], [\text{m}] \quad (10)$$

$\ell_{b,inf,i}$ is the distance between the point where the reinforcement bar intersects the critical shear crack and its lower anchorage plate; $d_{inf,i}$ is the diameter of the lower anchorage plate. It should be noted that this formula is dimension dependent and SI units should be introduced [MN, m].

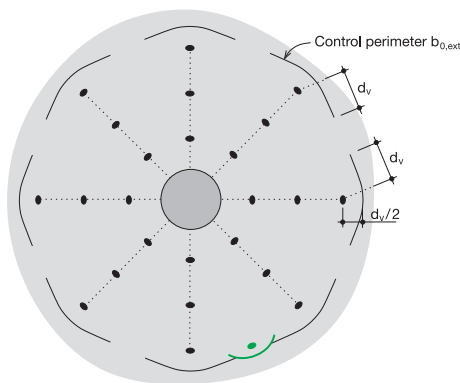

Fig. 15: external perimeter

3.4 Punching outside the reinforced area

The size of the reinforced area must be sufficient, so that the punching shear resistance outside the reinforced zone is inferior to the acting shear force on the column minus those forces acting inside the reinforced area. The punching shear resistance outside of the reinforced area is evaluated according to the applicable structural concrete code. It should be noted that the statical height d_v is reduced if the lower anchorage is inside the plate for fire protection or esthetic reasons (see fig. 13). The critical perimeter is defined by the diameter of the strengthened area. From the anchorage of a strengthening anchor a perimeter of not more than two times the effective depth can be taken into account (fig. 15). The external perimeter can be increased by adding intermediate anchors between those with a tangential distance of more than $2d$ (see green parts in fig. 15).

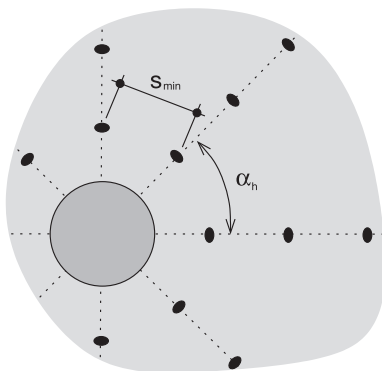

Fig 16: angle between radials

3.5 Rules for good detailing

In order to obtain a good detailing, the following constructive rules should be followed when designing punching shear reinforcement with Hilti Tension Anchors HZA-P:

3.5.1 Number of radii

The Hilti Tension Anchors HZA-P are placed along a series of radials where the angle between them has to be lower than or equal to 45°:

$$\alpha_h \leq 45^\circ$$

3.5.2 Number of reinforcements in a radial

At least two Hilti Tension Anchors HZA-P should be placed at each radial.

3.5.3 Distance between reinforcements and column

The distance of the first anchorage to the border of the column should be lower than or equal to $0.75d$ where d is the average effective depth of the structure to be strengthened ($d = (d_x + d_y) / 2$):

$$s_0 \leq 0.75d$$

If a very small value of s_0 is selected, the capacity of the first reinforcement bar may be strongly reduced. The presented design concept takes this into account. Moreover a small distance s_0 may lead to difficulties if there is dense column reinforcement.

3.5.4 Radial distance between reinforcements

The distance between two anchorages in a radial should be lower than or equal to $0.75d$:

$$s_1 \leq 0.75d$$

3.5.5 Axial distance

The minimum distance between axes of HZA-P bars (s_{min} , see figure 16) has to be greater than 3 times the diameter of the bore hole. In absence of other data:

- for HZA M16: $s_{min} = 170 \text{ mm}$
- for HZA M20: $s_{min} = 200 \text{ mm}$

3.5.6 Direction of the drilled holes

The direction of the drilled holes should be at an angle of 45° compared to the slab surface and towards the column:

$$\beta_1 = 45^\circ$$

3.5.7 Length of the drilled holes

The height at which a Hilti Tension Anchor HZA-P should be bonded (h_b) is equal to d :

$$h_b = d$$

In cases where tensile reinforcement is intersected when the hole is being drilled, the bonded height (h_b) can be reduced in order not to cut the tensile reinforcement. The estimate of the strength of the system should be performed with a value of h_b that accounts for this possibility.

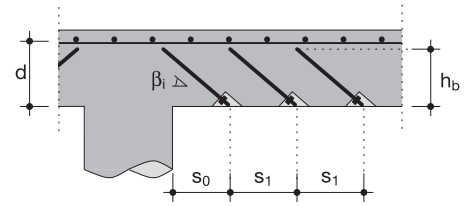

Fig. 17: distance between reinforcements

4 EXBAR punching design software

EXBAR punching is the design software for the strengthening of structural parts against punching shear with Hilti Tension Anchors HZA-P. It carries out the design according to section 3. The resistance of the non-reinforced structural part, the maximum possible punching resistance (failure of compressed concrete at limit of column) and the punching shear resistance outside of the reinforced area are calculated by section 3. They should also be checked by the designer according to the applicable structural concrete code. The user enters all necessary data on the entry screen. If the concrete contribution should not exceed that given by the applicable structural code, this value can be entered as “concrete contribution according to code”.

HILTI		Punching	
customer:	strengthening for punching shear with HILTI HZA-P	offer:	page
Hilti Aktiengesellschaft FL-9494 Schaan	part:	project:	
EXBAR-Punching B2.6 V 2.0	tbl.:	list number:	
	name:	date:	
		project name:	
Loads and Material Parameters			
design value of column load	$V_d = 700$ kN	yield strength of slab reinforcing steel	$f_{yd} = 435$ N/mm ²
design value of load on slab	$Q_s = 2$ kN/m ²	concrete quality	28 days design value
load on column during rehabilitation (service load level)	$V_{SL,S} = 300$ kN	maximum aggregate size	$D_{max} = 32$ mm
factor for load eccentricity	$k_e = 0.9$	concrete contribution according to code	$V_{Rd,C,C} =$ kN
Geometry			
distance column - contraflexure in x/y-direction [mm]	$r_{x1}/r_{y1} = 1650 / 1650$	slab thickness	$h = 300$ mm
effective depth in x/y-direction [mm]	$d_x/d_y = 250 / 250$	length in x-direction	$a = 450$ mm
upper reinforcement in x/y-direction [mm ² /m]	$A_{s1}/A_{s2} = 963 / 963$	length in y-direction	$b = 450$ mm
		rectangular column	
		internal column	
-> strengthening possible with HZA-P			

Based on the evaluation of the punching shear resistance of the non-reinforced slab and on the maximum possible punching shear resistance of the reinforced part, the user is informed, whether reinforcing with Hilti HZA-P is possible. If this is the case, the user can enter data concerning the type of reinforcing bars, the embedment of the lower anchorage Δh_{inf} , the height over which the bars are anchored h_b , the distance between the first anchorage and the column edge s_0 , the radial distance between two reinforcements s_1 and the number of radials n_s .

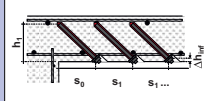
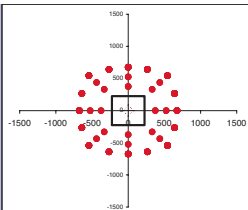
Strengthening Layout		HILTI HIT-RE 500	
Adhesive		HZA-P M16	
strengthening anchor type	$\Delta h_{inf} = 40$ mm		
niche depth for lower anchorage	$h_b = 250$ mm		
maximum height of shear reinforcement ($\max\{d_x, d_y\} - 50 \leq h_b \leq h - 30$)	$s_0 = 150$ mm		
radial distance column - 1 st anchor ($0.25d \leq s_{0y} \leq 0.75d$)	$s_1 = 150$ mm		
radial distance between anchors ($0.25d \leq s_1 \leq 0.75d$)	$n_s = 8$		
number of radials (at least 8)			
strengthening ok			

When entering the above data, the user is constantly informed whether the selected reinforcing arrangement is sufficient or not. The number of reinforcements in one radial is automatically selected in such a way that proof of the punching shear resistance outside of the reinforced area can be performed with the model of section 3.

Once the user has selected a satisfying reinforcement arrangement, he finds all the necessary design proofs on a separate screen which can be printed and added to a structural design document.

5 Examples

5.1 Strengthening of a ceiling

Given

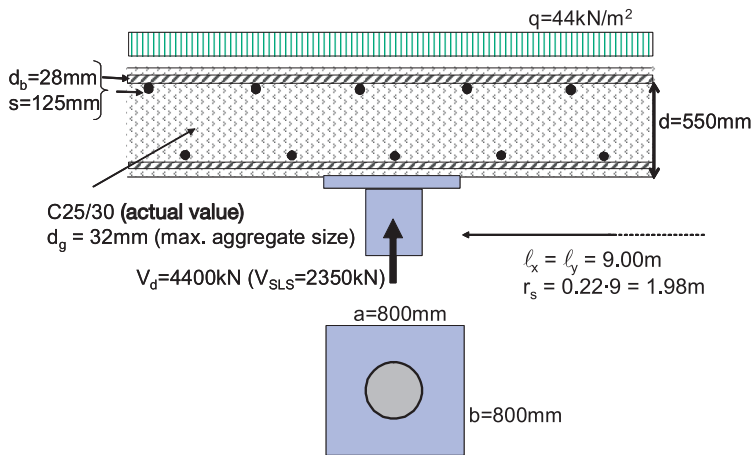

Punching shear resistance of non-reinforced slab (as evaluated by the applicable structural concrete code):

$$V_{Rd,c,c} = 3500 \text{ kN}$$

$$V_{Rd,c,c} < V_d$$

Therefore, the slab needs to be strengthened.

Suitability of Hilti HZA-P system

Critical shear perimeter

$$k_s = 0.9 \text{ (internal column)}$$

$$u^i = 0.9 \cdot (4 \cdot 800 + 2 \cdot 275 \cdot \pi)$$

$$= 4435 \text{ mm}$$

Area inside critical shear perimeter

$$A_i = 0.800^2$$

$$+ 4 \cdot 0.275 \cdot 0.800$$

$$+ 0.275^2 \cdot \pi$$

$$= 1.76 \text{ m}^2$$

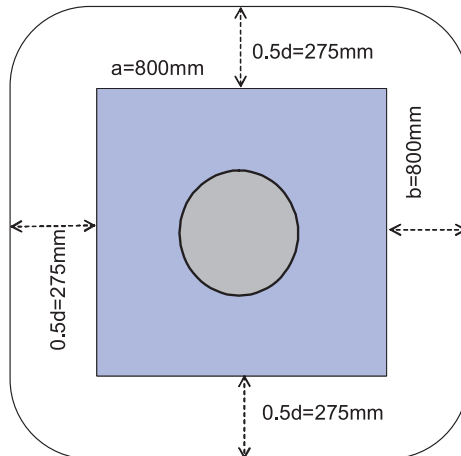

Punching shear load acting outside the critical shear perimeter:

$$V^*d = 4400 - (44 + 0.6 \cdot 25) \cdot 1.76 = 4296 \text{ kN}$$

Tensile reinforcement ratio of slab:

$$A_{sx} = A_{sy} = \frac{28^2 \cdot \pi}{4} \cdot \frac{1000}{125} = 4926 \text{ mm}^2 / \text{m}$$

Inner lever arm

$$z \cong 0.9 \cdot d = 0.9 \cdot 550 = 495 \text{ mm}$$

Design bending resistance

$$m_{Rd} = A_{sx} \cdot f_{yd} \cdot z = 4926 \cdot 435 \cdot 495 \cdot 10^{-6} = 1061 \text{ kNm} / \text{m}$$

Factor for long term effects

$$\text{actual value} \rightarrow \eta_l = 0.85$$

First estimate of max. punching resistance

$$V_{Rd,max,HZA-P,0} = 4500 \text{ kN}$$

Rotation under $V_{Rd,max,HZA-P,1}$

$$\psi_{d1} = 1.5 \cdot \frac{r_s}{d} \cdot \frac{f_{yd}}{E_s} \cdot \left(\frac{V_{Rd,max,HZA-P,0}}{a \cdot m_{Rd}} \right)^{3/2} = 0.00442 \quad (a=8, \text{ interior column}) \quad (2)$$

Calculation of max. punching resistance

$$V_{Rd,max,HZA-P1} = \frac{2.6 \cdot 2 \cdot \eta_l \cdot \sqrt{f_{ck}}}{4.5 \cdot \left(1 + 20 \cdot \frac{\psi_{d1} \cdot d}{d_g + 16} \right)} \cdot u' \cdot d / 1000 = 5949 \text{ kN} \quad (3)$$

Second estimate of max. punching resistance

$$V_{Rd,max,HZA-P,3} = (V_{Rd,max,HZA-P,0} = V_{Rd,max,HZA-P,1}) / 2 = 5225 \text{ kN}$$

... Some iterations with formulae (2) and (3)

Final maximum punching resistance

$$V_{Rd,max,HZA-P} = 5256 \text{ kN} > V'_d \rightarrow \text{strengthening possible with HZA-P!}$$

Parameters for design of reinforcement

Reinforcement type: Hilti HZA-P M20 bonded in with Hilti HIT-RE 500

Bond strength:

$$\tau_{bd} = 6.67 \cdot \left(\frac{f_{ck}}{25} \right)^{0.1} = 6.67 \cdot \left(\frac{30}{25} \right)^{0.1} = 6.79 \text{ N} / \text{mm}^2 \quad (\text{table 2})$$

Anchorage factor:

$$K_a = 3.67 \cdot \left(\frac{f_{ck}}{25} \right)^{0.05} = 3.70 \text{ MN} \cdot \text{m}^{0.5} \quad (\text{table 1})$$

Diameter anchor plate

$$d_{inf} = 60 \text{ mm} \quad (\text{section 2})$$

Rotation under design load:

$$\psi_d = 1.5 \cdot \frac{r_s}{d} \cdot \left(\frac{V_d}{a \cdot m_{Rd}} \right)^{3/2} \cdot \frac{f_{yd}}{E_s} = 0.00428 \quad (2)$$

Concrete contribution to shear resistance:

$$V_{Rc,d} = \frac{2 \cdot \eta_l \cdot \sqrt{f_{ck}}}{4.5 \cdot \left(1 + 20 \cdot \frac{\psi_d \cdot d}{d_g + 16} \right)} \cdot d \cdot u' / 1000 = 2738 \text{ kN} \quad (1)$$

Shear force to be taken up by reinforcement

$$V_{Rd,s,rqd} = V'_d - V_{Rd,c} = 1558 \text{ kN} \quad (4)$$

Selection of reinforcement layout

$$\begin{aligned}
 h_{i1} &= s_1 / 2 &= 150\text{mm} & \quad h_{i2} &= 300\text{mm} & \quad h_{i3} &= 450\text{mm} \\
 \ell_{b,\text{inf}1} &= (h_{i1} - \Delta h_{\text{inf}}) \cdot \sqrt{2} &= 141\text{mm} & \quad \ell_{b,\text{inf}2} &= 354\text{mm} & \quad \ell_{b,\text{inf}3} &= 567\text{mm} \\
 \ell_{b,\text{sup}1} &= (h_b - h_{i1}) \cdot \sqrt{2} &= 537\text{mm} & \quad \ell_{b,\text{sup}2} &= 325\text{mm} & \quad \ell_{b,\text{sup}3} &= 113\text{mm}
 \end{aligned}$$

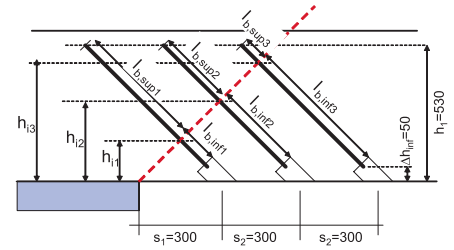

Design proof for selected layout

Rotation difference between SLS and ULS:

$$\Delta\psi_d = 1.5 \cdot \frac{r_s}{d} \cdot \frac{f_{yd}}{E_s} \cdot \left[\left(\frac{V_u}{8m_{Rd}} \right)^{1.5} - \left(\frac{V_{SLS}}{8m_{Rd}} \right)^{1.5} \right] = 1.5 \cdot \frac{1.98}{0.55} \cdot \frac{435}{205000} \cdot \left[\left(\frac{4400}{8 \cdot 1061} \right)^{1.5} - \left(\frac{2350}{8 \cdot 1061} \right)^{1.5} \right] = 0.00261 \quad (2a)$$

Activation of bar 1 due to rotation:

$$N_{s1,el,d} = K_{ai} \cdot \sqrt{\Delta\psi_d \cdot h_{i1}} = 3.70 \cdot \sqrt{0.00261 \cdot 0.15} = 0.073\text{MN} = 73.0\text{kN} \quad (7)$$

Steel strength bar 1:

$$N_{s1,pl,d} = A_s \cdot f_y = \frac{20^2 \cdot \pi}{4} \cdot 0.435 = 137\text{kN} \quad (8)$$

Bond strength above crack bar 1:

$$N_{s1,b,d} = \tau_{bd} \cdot d_b \cdot \pi \cdot \ell_{b,\text{sup}1} = 6.79 \cdot 20 \cdot \pi \cdot 537 \cdot 10^{-3} = 229\text{kN} \quad (9)$$

Concrete cone strength below crack bar 1:

$$\begin{aligned}
 N_{s1,p,d} &= A_s \cdot \frac{0.360}{\gamma_c} \cdot \sqrt{f_{ck}} \cdot \frac{\ell_{b,\text{inf}1}^{1.5}}{d_b^2} \left(1 + \frac{d_{\text{inf}}}{\ell_{b,\text{inf}1}} \right) \\
 &= \frac{0.02^2 \cdot \pi}{4} \cdot \frac{0.360}{1.5} \cdot \sqrt{25} \cdot \frac{0.141^{1.5}}{0.02^2} \left(1 + \frac{0.06}{0.141} \right) = 0.07\text{MN} = 70.7\text{kN}
 \end{aligned} \quad (10)$$

Design strength bar 1:

$$N_{s1,d} = \min(N_{s1,el,d}; N_{s1,pl,d}; N_{s1,b,d}; N_{s1,p,d}) = \min(73.0; 137; 229; 70.7) = 70.7\text{kN} \quad (6)$$

Design strength bar 2:

$$N_{s2,d} = \min(N_{s2,el,d}; N_{s2,pl,d}; N_{s2,b,d}; N_{s2,p,d}) = \min(104; 137; 139; 232) = 104\text{kN} \quad (6)$$

Design strength bar 3:

$$N_{s3,d} = \min(N_{s3,el,d}; N_{s3,pl,d}; N_{s3,b,d}; N_{s3,p,d}) = \min(127; 137; 48.2; 439) = 48.2\text{kN} \quad (6)$$

Design strength radial in direction of bars:

$$N_{sd} = N_{s1} + N_{s2} + N_{s3} = 70.7 + 104 + 48.2 = 223\text{kN} \text{ per radius}$$

Design strength radial in direction of load:

$$V_{sd,r} = N_{sd} \cdot \sin 45^\circ \cdot k_e = 142\text{kN} \text{ per radius}$$

Number of radials required:

$$n \geq \frac{V_{s,rqd}}{V_{sd,r}} = \frac{1558}{142} = 10.97 \rightarrow \text{select 12 radii}$$

To strengthen the slab against the punching shear load of 4400kN, 36 anchors HZA-P M20 are required in the layout shown on the right.

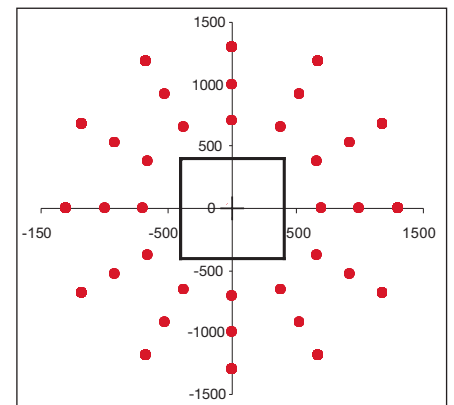

Punching shear resistance outside the reinforced area

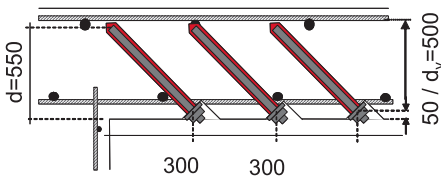

The punching shear resistance outside the reinforced area should be calculated according to the applicable structural concrete code. In this calculation the effective depth of the slab should be reduced by the 50 mm that the lower anchorages are inside the slab ($d_v = 500$ mm). If the punching shear resistance outside the reinforced area is not sufficient, then additional anchors Hilti HZA-P can be added to each radial until the external perimeter is large enough. If the lateral distance between anchors becomes larger than $2d_v$, then intermediate anchors should be added as described in section 3.4.

5.2 Corner column

Entry EXBAR-Punching

Definition of parameters in entry section of EXBAR-Punching

HILTI		Punching	
customer:	strengthening for punching shear with Hilti HZA-P	page:	
Hilti Aktiengesellschaft FL-9494 Schaan	part:	title:	
EXBAR-Punching B2.6 V 2.0		project:	
		list number:	
		date:	
		project name:	
Loads and Material Parameters			
design value of column load	$V_d = 250$ kN	yield strength of slab reinforcing steel	$f_{yd} = 460$ N/mm ²
design value of load on slab	$q_d = 5$ kN/m ²	concrete quality	28 days design value C35/45
load on column during rehabilitation (service load level)	$V_{sl,s} = 150$ kN	maximum aggregate size	$D_{max} = 32$ mm
factor for load eccentricity	$k_e = 0.7$	concrete contribution according to code	$V_{Rd,c} =$ kN
Geometry			
distance column - contraflexure in x/y-direction [mm]	$r_{ed}/r_{eq} = 1650 \quad 1650$	slab thickness	$h = 350$ mm
effective depth in x/y-direction [mm]	$d_x/d_y = 300 \quad 300$	length in x-direction	$a = 450$ mm
upper reinforcement in x/y-direction [mm ² /m]:	$A_{su}/A_{sy} = 963 \quad 963$	length in y-direction	$b = 450$ mm
lower reinforcement in x/y-direction [mm ² /m]:	$A_{su}/A_{sy} = 617 \quad 617$	min. distance column-edge:	$sr = 100$ mm
-> strengthening possible with HZA-P			

Definition of an appropriate reinforcement layout

Strengthening Layout		Hilti HIT-RE 500	
Adhesive	HZA-P M16	$\Delta h_{int} = 40$ mm	
strengthening anchor type		$h_1 = 250$ mm	
niche depth for lower anchorage		$s_0 = 200$ mm	
maximum height of shear reinforcement ($\max(d, d_v) - 50 \leq h_1 \leq h - 30$)		$s_1 = 200$ mm	
radial distance column - 1 st anchor ($0.25d \leq s_0 \leq 0.75d$)		$n_a = 5$	
radial distance between anchors ($0.25d \leq s_1 \leq 0.75d$)			
number of radii (at least 4)			
strengthening ok			

Design proof from EXBAR-Punching

HILTI		customer:	strengthening for punching shear with Hilti HZA-P		page 1		
Hilti Aktiengesellschaft FL-9494 Schaan			part:	offer:			
EXBAR-Punching B2.6 V 2.0		tel.:		project:			
		name:		list number:			
				date:			
				project name:			
Given							
Geometry							
slab thickness	h =				350 mm		
effective depth	d _y =				300 mm		
	d _x =				300 mm		
distance column -> contraflexure	r _{sx} =				1650 mm		
	r _{sy} =				1650 mm		
corner column	sr =	(min. Abstand Stütze - Rand)			100 mm		
rectangular column	a =				450 mm		
	b =				450 mm		
Loads							
design column load	V _d =				250 kN		
design load on slab	q _d =				5 kN/m ²		
service load at installation	V _{SLS} =				150 kN		
factor for load eccentricity	k _e =				0.70		
Concrete quality							
					C35/45		
characteristic compressive strength	f _{ck} =				35 N/mm ²		
factor for 28 days design value	η _{1t} =				1		
design compressive strength	f _{cd} =				22 N/mm ²		
maximum aggregate diameter	D _{max} =				32 mm		
Bending reinforcement							
			x lower	y lower	x upper	y upper	
area of reinforcing steel	A _{s,i} =		617	617	963	963	mm ² /m
design yield strength	f _{yd} =						460 N/mm ²
Punching shear resistance without strengthening							
average effective depth	d = (d _x + d _y) / 2 =					300 mm	
critical perimeter for punching shear	u =					796 mm	
area inside critical section	A _i =					0.33 m ²	
load outside critical section	V' _d = V _d - A _i · (q _d + h·25) =					245 kN	
check of bending reinforcement							
			x lower	y lower	x upper	y upper	
• factor for position	a: corner column → a =		2	2	2	2	
• bending resistance	m _{Rd} =		83	83	128	128	kNm/m
rotation under design load	ψ _d = 1.5·r _y /d(V _d /a·m _{Rd}) ^{1.5} ·f _{yd} /E _s =						0.0343
punching resistance before strengthening	V _{Rd,c1} = 2·η _{1t} ·f _{ck} ^{0.5} ·[4.5·(1+20·ψ _d ·d/(D _{max} +16))]·u·d =						119 kN
critical concrete contribution	V _{Rd,c} = min[V _{Rd,c1} ; V _{Rd,c,c}] =						119 kN
V'_d > V_{Rd,c}							→ punching shear resistance not sufficient
maximum punching shear resistance	VRd,max =						275 kN
V_d ≤ VRd,max							→ strengthening possible with Hilti HZA-P
<small>Entries must be verified with conditions on site and results must be checked for plausibility</small> <small>B 2.6 V 2.0 07/2009 © 2009 Hilti AG, FL-9494 Schaan Hilti is registered trademark of the Hilti Corporation</small>							

Part 1 of design output of EXBAR-Punching: Input summary, calculation of bending and punching shear resistance of slab without shear reinforcement, check if strengthening with Hilti HZA-P is possible without crushing of concrete under compression

Part 2 of design output of EXBAR-Punching: description of selected arrangement and design proof for strengthening anchors Hilti HZA-P

	customer:	Verstärkung gegen Durchstanzen mit HZA-P	Seite 2
Hilti Aktiengesellschaft FL-9494 Schaan		Bauteil:	Angebot:
	tel.:		Projekt
	name:		Listennummer:
EXBAR-Punching B2.6 V 2.0			Datum:
			Projekt Name:

selected strengthening arrangement

adhesive	Hilti HIT-RE 500	hole length from concrete surface	$l_b =$	354 mm
strengthening anchors	Hilti HZA-P M16	vertical depth of void	$\Delta h_{inf} =$	40 mm
number of radials	$n_s =$	distance column - 1 st anchor	$s_0 =$	200 mm
anchors per radial	$n_v =$	radial distance between anchors	$s_1 =$	200 mm

drawings

Hilti HZA-P M16 per radial

design proof for selected strengthening arrangement

yield strength of strengthening anchor	$f_{yd,HZA} =$	435 N/mm ²
rotation from installation to design load	$\Delta\psi = 1.5 \cdot s/d \cdot [(V_d/a \cdot m_{Rd})^{1.5} \cdot (V_{si,s}/a \cdot m_{Rd})^{1.5}] \cdot f_{yd}/E_s =$	0.0184
design bond strength	$\tau_{bd} =$ (ETA-04/0027)	7.1 N/mm ²
anchorage factor	$K_a =$ Hilti HZA-P M16 Hilti HIT-RE 500 C35/45	2.70 MNm ^{-0.5}
diameter strengthening anchor	$d_b =$ Hilti HZA-P M16 →	16 mm
diameter anchorage plate	$d_{inf} =$ Hilti HZA-P M16 →	52 mm

resistance in 45°-shear crack from column edge

bar	s	h _i	l _{b,inf}	l _{b,sup}	N _{si,el,d}	N _{si,pl,d}	N _{si,b,d}	N _{si,p,d}	N _{si,d}
	[mm]	[mm]	[mm]	[mm]	[kN]	[kN]	[kN]	[kN]	[kN]
1	200	100	85	212	115.6	87.5	75.4	44.0	44.0
2	400	200	226	71	163.5	87.5	25.1	146.2	25.1
3	600	300	368	0	200.2	87.5	0.0	281.0	0.0
4	800	400	509	0	231.2	87.5	0.0	442.1	0.0
5	1000	500	651	0	258.5	87.5	0.0	625.8	0.0

resistance per radial in direction of bars	$N_{Rd,s,s} =$	69.2
resistance per radial in direction of shear force	$V_{Rd,s,s} = N_{Rd,s,s} / \sqrt{2} \cdot k_e =$	34.2

formulae used:

activated bar force	$N_{si,el,d} = K_s \cdot [\Delta\psi \cdot h]^{0.5}$	
yield force of bar	$N_{si,pl,d} = \pi \cdot d_b^2 \cdot f_{yd,HZA}$	
upper anchorage (bond)	$N_{si,b,d} = \pi \cdot d_b \cdot l_{b,sup} \cdot \tau_{bd}$	
lower anchorage (cone)	$N_{si,p,d} = 0.28 / \gamma_c \cdot f_{ck}^{0.5} \cdot l_{b,inf}^{1.5} \cdot (1 + d_{inf} / l_{b,inf})$	[N/mm ² , m, MN]

Entries must be verified with conditions on site and results must be checked for plausibility

B 2.6 V 2.0 07/2009
© 2009 Hilti AG, FL-9494 Schaan
Hilti is registered trademark of the Hilti Corporation

 Hilti Aktiengesellschaft FL-9494 Schaan	customer:	Verstärkung gegen Durchstanzen mit HZA-P		Seite 3
	tel.:	Bauteil:	Angebot:	
	name:		Projekt:	
			Listennummer:	
EXBAR-Punching B2.6 V 2.0			Datum:	
			Projekt Name:	

Part 3 of design output of EXBAR-Punching: considerations for punching outside strengthened area, number of anchors required and detailing hints.

contribution of shear reinforcement	$V_{Rd,s} = V_{Rd,s,s} \cdot \eta_s =$	171 kN
punching resistance after strengthening	$V_{R,d} = V_{Rd,s} + V_{Rd,c} \leq V_{Rd,max} =$	275 kN

$$V'_d \leq V_{Rd} \rightarrow \text{ok}$$

Punching shear resistance outside strengthened area

Evaluation of the punching shear resistance according to the method of the critical shear crack as described in the documentation. The applicable structural concrete code may require a greater diameter of the strengthened area. In this case the radials need to be extended by additional anchors with the same radial distance between anchors s_1 .

reduced effective depth	$d_v = d - \Delta h_{inf} =$	260 mm
diameter of circular column of same area	$D_c =$	507.77 mm
length of radials	$\ell_s = s_0 + (n_r - 1) \cdot s_1 =$	1000 mm
external perimeter	$u_a = k_E \cdot (D_c + 2 \cdot \ell_s + d_v) \cdot \pi / 4 + k_e \cdot d_v =$	1704 mm
area inside u_a	$A_a =$	2.16 m ²
punching shear load outside u_a	$V'_{a,d} = V_d - A_a \cdot (q_d + h \cdot 25) \geq 0 =$	220 kN
punching shear resistance under V_d	$V_{Rda,c} = 2 \cdot \eta_1 \cdot f_{ctk}^{0.5} / [4.5 \cdot (1 + 20 \cdot \psi_{ef} \cdot d / (D_{max} + 16))] \cdot u_a \cdot d_v =$	247 kN

$$V'_d \leq V_{Rda,c} \rightarrow \text{ok}$$

strengthening: 25 Hilti HZA-P M16 , arranged according to drawings on page 2

Intermediate anchors are required where the polar distance between two anchors exceeds twice the reduced effective depth ($s_{rad} > 2d_v$). If required, they are included in the number of anchors quoted above.

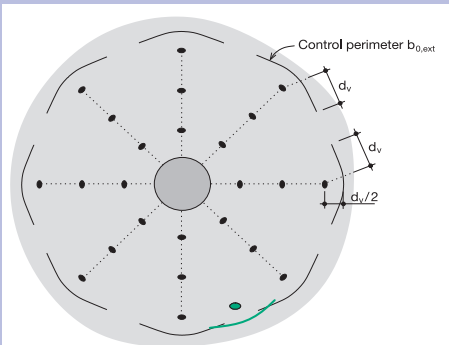

Entries must be verified with conditions on site and results must be checked for plausibility

6 Test results



Fig. 18: failure patterns

Hilti has performed tests where shear reinforcement HZA-P was bonded into drilled holes inclined towards the column. This is a continuation of a system that has been investigated at the Royal Institute of Technology KTH in Stockholm in 1995 [4].

It is important that the drilled holes proceed up to at least just below the tensile reinforcement of the slab. As the anchorage quality has a strong influence on the efficiency of shear reinforcement, the reinforcing bars were anchored at the bottom of the bar with an anchorage plate and a nut. In a first step beam tests have shown that the number of reinforcement bars and the characteristics of the used adhesive mortar have the strongest influence on the result.

Slab tests carried out subsequently have shown increases of resistance up to the theoretically possible maximum punching shear resistance. The results of these tests were incorporated into a consistent design concept by Professor A. Muttoni at the Swiss Federal Institute of Technology (ETH) in Lausanne.

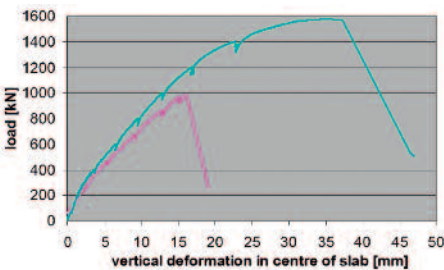

Fig. 19: Load vs. displacement curves

In addition to the increase in resistance, slabs reinforced with Hilti Tension Anchors HZA-P also provide a significantly increased deformation capacity. The failure is definitely less brittle than that of non-reinforced slabs. Figure 19 shows the comparison of two tests with a relatively high tension reinforcement ratio. The non-reinforced slab failed at a load of about 1000 kN in a very brittle way. On the other hand, the reinforced slab failed outside of the reinforced area at about 1600 kN after a clear plastic deformation. This corresponds to an increase of the load capacity of 60% and to twice of the deformation capacity. Due to the increased deformation capacity, loads can be redistributed to neighbouring columns in case of overloading, which increases the safety of the overall structure.

7 References

- [1] Mentétrey, Ph., Brühwiler, E., "Shear Strengthening of existing reinforced concrete slabs under concentrated loads", EPFL – Repr – 1996
- [2] Muttoni, A.: Punching Shear Strength of Reinforced Concrete Slabs without Transverse Reinforcement. ACI structural journal, Vol. 105/4, Farmington Hills, MA, 2008
- [3] Muttoni, A., Fernández Ruiz M.: Design Method for Post-Installed Punching Shear Reinforcement with Hilti Tension Anchors HZA-P. Lausanne, 2009.
- [4] Hassanzadeh, G., "Förstärkning av brobanep Plattor med häsyn till stansing" („Strengthening of bridge slabs with respect to punching"), Master of Civil Engineering Thesis, KTH, Stockholm, 1995 (in Swedish)

8 Installation procedure

8.1 Detection and marking of the existing lower reinforcement

An area of at least 180 cm x 180 cm of the slab around the column is detected with the Ferroskan System PS 200 and the lower reinforcement is marked. Then, the pattern of the anchorages is marked.

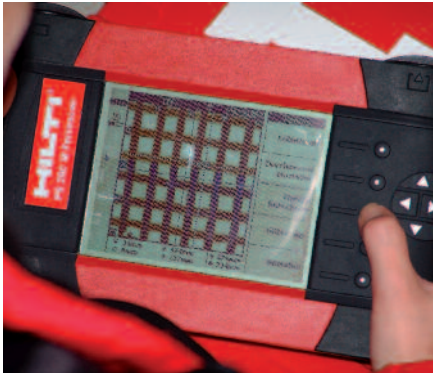

Fig. 20: location of reinforcement with Ferroskan PS 200

8.2 Drilling and anchoring

Hilti HIT and HIT-RE 500
Installation guide for fastenings in concrete

The installation guide described here is a reduced version of the installation guide for fastenings in concrete (V.1.2), called "Hilti HIT".

In this FTM the focus is on the installation procedure for Hilti Tension Anchors HZA-P which will be installed overhead. The installation length is limited to 800 mm. For the complete installation guide for fastenings in concrete the reader has to refer "Hilti HIT" (384756 / B 12.2007).

- **Observe this guide for use and safety precautions before using Hilti HIT systems.**
- **International and national approvals take precedence for approval governed applications.**
- **Observe the Instructions for Use provided with each foil pack and the dispenser in use.**
- **For updates of the present document, please refer to www.hilti.com.**
- **For the availability of the Hilti products referenced in this document, please contact your local Hilti representative.**

Safety Regulations:

- Review the Material Safety Data Sheet (MSDS) before use!
- Wear well-fitting safety glasses, protective gloves and suitable protective clothing when working with Hilti HIT.
- Read the Installation guide!



8.2.1 Borehole drilling

Base material condition

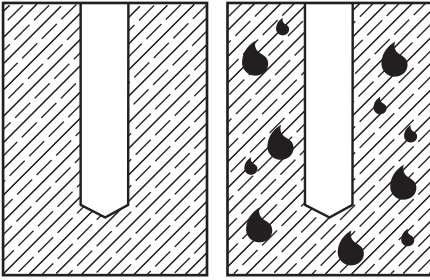

Dry / water saturated

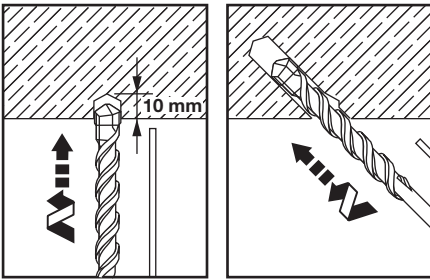

Hammer drilling

- Drill about 10 mm vertically upward
- Rotate tool
- Drill the boreholes under an angle of 45° to the surface to the required embedment depth using a hammer-drill with an appropriately sized carbide drill bit set in rotation hammer mode.
- The holes are drilled with the rotary hammer TE 76 and the following drill bits:

Use the following drill bits:

- For HZA-P M16: Ø 22 mm (TE-YX 22/92)
- HZA-P M20: Ø 25 mm (TE-YX 25/92)



Fig. 21: Drilling of the holes

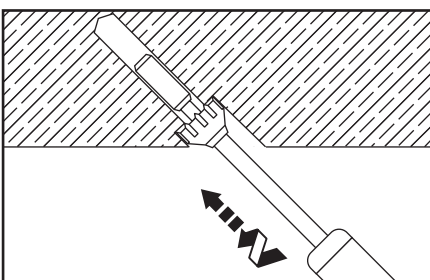

8.2.2 Extension of drill holes for lower anchorage

With HZA-P M16: use special drill bit TE-Y-GB 55/59

With HZA-P M20: use special drill bit TE-Y-GB 66/59



8.2.3 Borehole cleaning

Load performances of chemical anchors are strongly influenced by the cleaning method. Inadequate borehole cleaning = poor load values. For safety relevant applications, please verify with the design engineer which cleaning method was assumed in the design phase. The borehole must be free of dust, debris, water when applicable, ice, oil, grease and other contaminants prior to mortar injection.

a) Compressed air

- Blow from the back of the borehole with oil-free compressed air, min. 6 bar at 6 m³/hour until return air stream is free of noticeable dust. Perform this step 2 times.
- For boreholes deeper than 250 mm, use the appropriate air nozzle Hilti HIT-DL (oil free compressed air ≥ 6 bar) – see Table II for the corresponding air nozzle / drill bit combination.

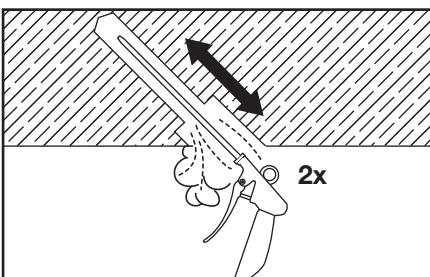

- Connect the selected air nozzle with the appropriate air cleaning extension: HIT-DL 20 or HIT-DL 25 with HIT-DL 16/0.8 or HIT-DL B and/or HIT-VL 16/0.7 and/or HIT-VL 16.

See Table II for the corresponding air nozzle / drill bit combination.

Tips:

- Keep away from dust cloud, do not inhale concrete dust.
- Hilti recommends a dust collector or other equipment to collect the dust during the blowing operation.

HIT-DL 20 or HIT-DL 25, respectively



b) Brushing

- Brush extensions HIT-RBS for machine brushing shall be used to accommodate cleaning of boreholes deeper than 250 mm.
- Select the corresponding brush extension HIT-RBS according to Table IV.
- Attach the round steel brush, HIT-RB, on one end of the brush extension(s) HIT-RBS, in order to reach the back of the borehole.
- Secure the other extension end into the TE-C/TE-Y (-T) holder.

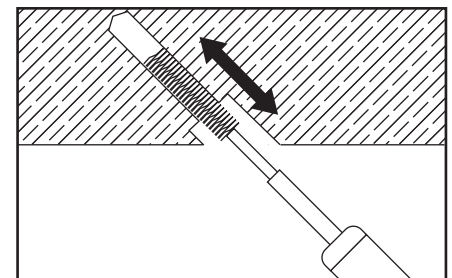

Tips:

- Start machine brushing operation slowly.
- Start brushing operation once brush is inserted in borehole.

Cleaning set:

Round steel brush
HIT-RB

Extension
HIT-RBS 10/0.7

Holder
TE-Y

Rotary hammer



Fig. 22: Equipment for borehole cleaning

c) Compressed air

- Blow out the hole again from the back of the hole with compressed air until return air stream is free of noticeable dust. Perform this step 2 times.

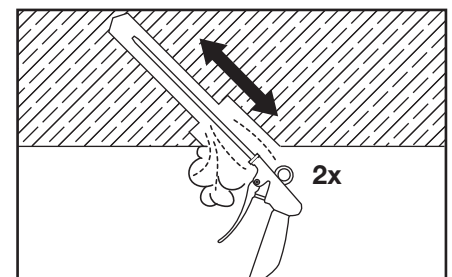

8.3 Injection preparation

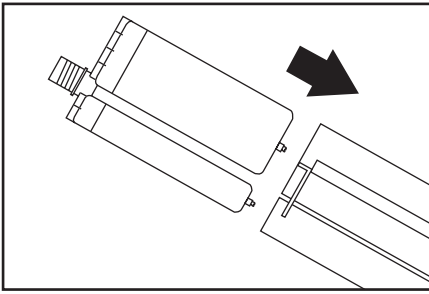

Insert foil pack in foil pack holder

- Observe the Instructions for Use of the dispenser.
- Check foil pack holder for proper function.
- Put foil pack into foil pack holder.
- Do not use damaged foil packs / holders.

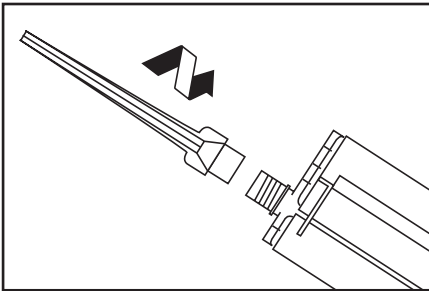

Tightly attach mixer to foil pack manifold

- Use the static mixer that is delivered with the mortar.
- Attach the static mixer tightly on to the manifold before starting to dispense.
- Do not modify the static mixer.
- If the use of injection extensions HIT-VL 16/0.7 or HIT-VL 16 is required, use mixer HIT-RE-M.

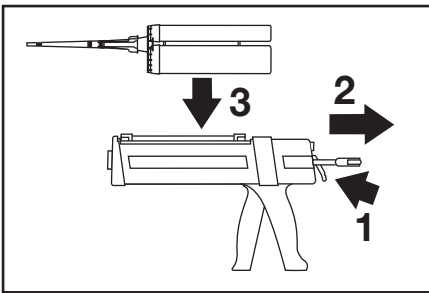

Insert foil pack holder with foil pack into dispenser

- Push release trigger (1), retract plunger (2) and insert foil pack holder with foil pack into the appropriate Hilti dispenser (3).

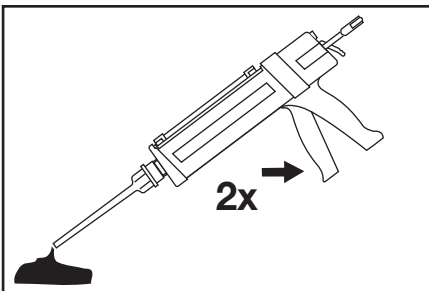

Discard initial amount of mortar

- Observe the Instructions for Use of the mortar for the amount of mortar that has to be discarded.
- The foil pack is self opening when dispensing begins.
- Do not pierce the foil pack manually (this can cause system failure).
- After changing a mixer, first trigger pulls must be discarded.
- For each new foil pack a new static mixer must be used.

8.4 Injection of mortar

Inject mortar into borehole starting from the back of the borehole without forming air voids

- Verify if borehole conditions have changed after cleaning. If yes, repeat cleaning steps.
- Inject the mortar from the back of the borehole after controlling that the depth of the borehole corresponds to the design value.
- Important! Use extensions for deep holes, as explained under special case.
- Fill holes approximately $\frac{2}{3}$ full, or as required to ensure that the annular gap between the anchor/rebar and the concrete is completely filled with mortar over the entire embedment length.

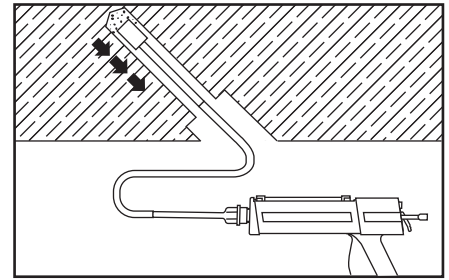

Special Case: Injection overhead



Take care!

- Observe the Instructions for Use of the mortar for the use of piston plugs HIT-SZ in case of overhead applications.
- If during an overhead application rigid elongations (HIT-VL 16/0.7) are used, the flexible hose HIT-VL (0.5 m) has to be used and connected to the static mixer.
- During the injection the elongations have to be secured in such a way that the pressure in the mortar during the injection is clearly noticeable.
- See Table II for the corresponding piston plug / drill bit combination.
- Connect the selected injection piston plug with the appropriate injection extension: HIT-SZ 22 and HIT-SZ 25 with HIT-VL 16 or HIT-VL 16/0.7
- To aid installation, mark the required mortar level ℓ_m and embedment depth ℓ_{inst} with tape or marker on the mixer extension.
- Quick estimation: $\ell_m \approx \frac{1}{3} \cdot \ell_{inst}$
- The mixer extension with the piston plug should be inserted to the back of the borehole without resistance.
- During the injection the piston plug will be naturally pushed out of the borehole by the mortar pressure.
- Attention! By pulling the mixer extension with piston plug, the piston plug may be rendered inactive and air voids may occur.
- Attention! Only the connection between static mixer and foil pack may be disconnected. In the case of injection with the dispenser HIT-P 8000 D, secure the connection between the new static mixer and the elongations by means of tape.

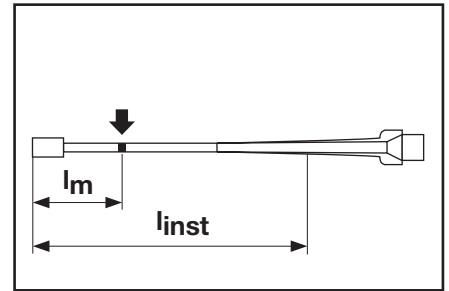

Depressurize the dispenser

- After injecting the mortar, depressurize the dispenser by pressing the release button. This will prevent further mortar from escaping out of the mixer.

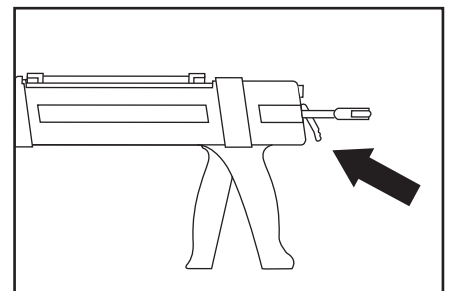

The efficient installation of the anchors is supported by the use of the large cartridges HIT-RE 500, 1400ml and the compressed air injection tool HIT-P 8000-D.



Fig. 23: Injection tool HIT-P 8000-D

8.5 Installation of the punching shear reinforcement

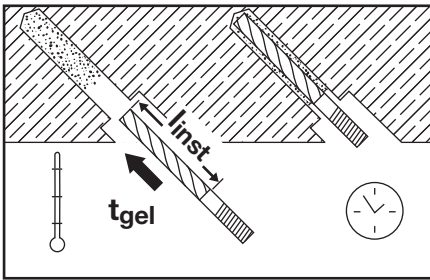

Insert element into the borehole

- Mark the element at the required embedment depth l_{inst} .
- Place the centre ring at the thread.
- Set the element to the required embedment depth. **Embedment depth must be equal to the design specification.**
- Before use, verify that the element is dry and free of oil or other residue.
- To ease installation, elements may be slowly twisted as they are inserted.
- After installing an element the annular gap must be completely filled with mortar.



- **Observe the gel time “ t_{gel} ”**, which varies according to the temperature of base material. Please refer to the Instructions for Use of the mortar for details about “ t_{gel} ”.
- Minor adjustments to the element may be performed during the gel time. For the gel time see relevant information in the Instructions for Use of the mortars.

Special Case: Installation overhead

- Take special care when inserting the element.
- Excess mortar will be forced out of the borehole and might start dripping. Contact with dripping mortar has to be avoided absolutely.
- To ease installation, use the overhead dripping cup (HIT-OHC 2, item no. 387552) and push it to the mark l_{inst} .
- Insert the element with the dripping cup into the borehole.

- Remove and dispose the overhead dripping cup with the excess mortar safely.
- After curing the mortar is harmless.
- The overhead dripping cup is a throw-away item.
- The element is secured during the curing time “ t_{cure} ” with the centre ring.

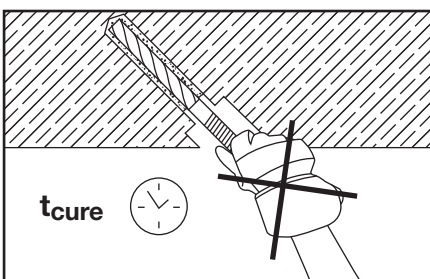

Do not disturb the element



- Once the gel time “ t_{gel} ” has elapsed, do not disturb the element until “ t_{cure} ” has passed. Please refer to the Instructions for Use of the mortar for details about “ t_{cure} ”.

After injection of the mortar, the tension anchor HZA-P is manually installed into the drilled hole as described in the section above.

8.6 Installation of anchor head

After curing of the injection mortar HIT-RE 500 the anchor head is installed, i.e. the injection washer HIT M16, spherical washer C17 und nut M16 or injection washer HIT M20, spherical washer C21 und nut M20 are fixed to the thread. The installation torque moment of 100 Nm (HZA-P M16) or 160Nm (HZA-P M20) is then applied.

Apply torque

- After " $t_{cure, full}$ " has passed torque " T_{inst} " may be applied. Please, refer to the Instruction for Use of the mortar for details about " $t_{cure, full}$ " and " T_{inst} ".

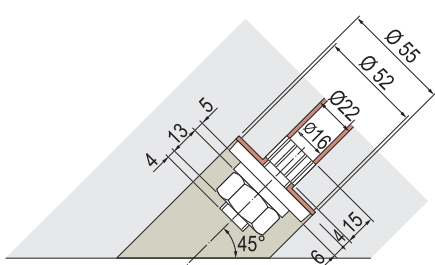
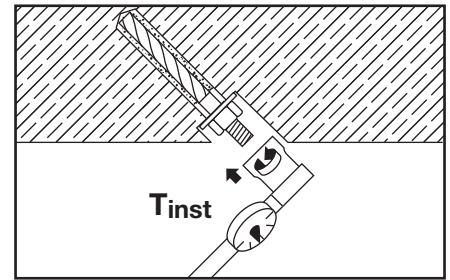

Fig. 24: Anchor head and hole extension HZA-P M16

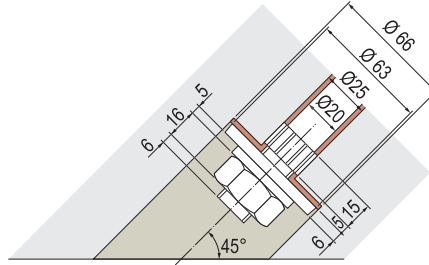

Fig 25: Anchor head and hole extension HZA-P M20

8.6.1 Injection of the washer with HIT-RE 500

After application of the torque moment, the washer of the anchor head is injected with adhesive mortar HIT-RE 500.

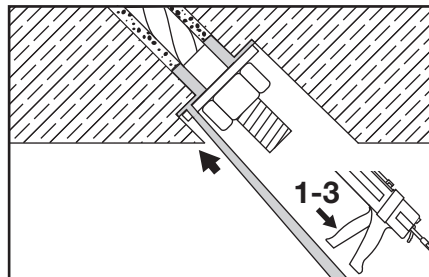
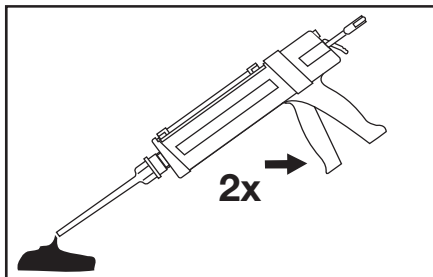

Fig. 26: Injection of dynamic set washer

8.7 Filling of hole extension with fire protection mortar CP 636

The anchor head is covered with fire protection mortar CP 636.



Fig. 27: Fire protection mortar CP 636

9 Materials

Drill bits



Ordering designation	for size	Item no.
TE-YX 22/32	M16	339021
TE-Y 22/52	M16	339022
TE-YX 25/32	M20	339026
TE-Y 25/52	M20	339027
TE-Y 25/92	M20	339028

Widening drill bits for embedment of the anchorage



Ordering designation	for size	Item no.
TE-Y GB 55/36	M16	261862
TE-Y GB 66/36	M20	261863

Material for hole cleaning



Ordering designation	for size	Item no.
Round brush HIT RB 22	M16	370774
Round brush HIT RB 25	M20	336553



Extension RB 10/07	M16 / M20	336645
--------------------	-----------	--------



Fitting RBS TE-C	M16 / M20	263437
------------------	-----------	--------



Pressurized air injector	M16 / M20	381215
--------------------------	-----------	--------



Air nozzle HIT DL 20	M16	371719
Air nozzle HIT DL 24	M20	371720



Extension Pressurized air injector	M20	336553
------------------------------------	-----	--------

Hilti tension anchor HZA-P



Ordering designation	Package contains	Item no.
HZA-P M16 x350	20 pieces incl. accessories	388729
HZA-P M20 x700	10 pieces incl. accessories	388730

The tension anchors HZA-P are delivered with their accessories, i.e. 1 injection washer, 1 spherical washer, 1 nut and 1 center ring per anchor. The total lengths are 350 mm for M16 and 700 mm for M20. They must be shortened according to the requirements of the project.

Injection mortar

Ordering designation	for size	Item no.
Hilti HIT-RE 500/1400	M16/M20	373958
Hilti HIT-RE 500/500	M16/M20	00305075



Mixer HIT-RE-M	M16/M20	337111
-----------------------	----------------	---------------



Extension tube HIT-VL-16/07	M16/M20	336646
------------------------------------	----------------	---------------



Piston plug HIT-SZ 22	M16	380922
Piston plug HIT-SZ 25	M20	380927



Fire protection mortar

Ordering designation	for size	Item no.
Fire protection mortar Hilti CP636-20	M16/M20	388729



Hilti. Outperform. Outlast.

Hilti Corporation | 9494 Schaan | Liechtenstein | Eva Floery P +423-234 3025 | F +423-234 2965 | www.hilti.com