

# HILTI

TE 700-AVR

English





# 1 Information about the documentation



## 1.1 About this documentation

- Read this documentation before initial operation or use. This is a prerequisite for safe, trouble-free handling and use of the product.
- Observe the safety instructions and warnings in this documentation and on the product.
- Always keep the operating instructions with the product and make sure that the operating instructions are with the product when it is given to other persons.

## 1.2 Explanation of symbols used



### 1.2.1 Warnings

Warnings alert persons to hazards that may occur when handling or using the product. The following signal words are used in combination with a symbol:

	<b>DANGER!</b> Draws attention to an imminent hazard that will lead to serious personal injury or fatality.
	<b>WARNING!</b> Draws attention to a potential hazard that could lead to serious personal injury or fatality.
	<b>CAUTION!</b> Draws attention to a potentially dangerous situation that could lead to minor personal injury or material damage.



### 1.2.2 Symbols in the documentation

The following symbols are used in this document:

	Read the operating instructions before use
	Instructions for use and other useful information

### 1.2.3 Symbols in the illustrations





The following symbols are used in illustrations:

	These numbers refer to the corresponding illustrations found at the beginning of these operating instructions.
3	The numbering reflects the sequence of operations shown in the illustrations and may deviate from the steps described in the text.
	Item reference numbers are used in the <b>overview illustration</b> and refer to the numbers used in the key in the <b>product overview</b> section.
	This symbol is intended to draw special attention to certain points when handling the product.

## 1.3 Symbols on the product

### 1.3.1 Symbols on the product

The following symbols are used on the product:

	Chiseling
	Chisel positioning
	Protection class II (double-insulated)
	Wear protective gloves

## 1.4 Product information

Hilti products are designed for professional use and may be operated, serviced and maintained only by trained, authorized personnel. This personnel must be informed of any particular hazards that may be encountered. The product and its ancillary equipment can present hazards if used incorrectly by untrained personnel or if used not in accordance with the intended use. The type designation and serial number are stated on the rating plate.

- ▶ Write down the serial number in the table below. You will be required to state the product details when contacting Hilti Service or your local Hilti organization to inquire about the product.

### Product information

Breaker	TE 700-AVR
Generation	01
Serial no.	

## 1.5 Declaration of conformity

We declare, on our sole responsibility, that the product described here complies with the applicable directives and standards. A copy of the declaration of conformity can be found at the end of this documentation.

The technical documentation is filed and stored here:

**Hilti** Entwicklungsgesellschaft mbH | Tool Certification | Hiltistraße 6 | 86916 Kaufering, DE

## 2 Safety

### 2.1 General power tool safety warnings

⚠ WARNING

**Read all safety warnings and all instructions.** Failure to follow the warnings and instructions may result in electric shock, fire and/or serious injury.

**Save all warnings and instructions for future reference.**

The term “power tool” in the warnings refers to your mains-operated (corded) power tool or battery-operated (cordless) power tool.

## Work area safety

- ▶ **Keep work area clean and well lit.** Cluttered or dark areas invite accidents.
- ▶ **Do not operate power tools in explosive atmospheres, such as in the presence of flammable liquids, gases or dust.** Power tools create sparks which may ignite the dust or fumes.
- ▶ **Keep children and bystanders away while operating a power tool.** Distractions can cause you to lose control.

## Electrical safety

- ▶ **Power tool plugs must match the outlet. Never modify the plug in any way. Do not use any adapter plugs with earthed (grounded) power tools.** Unmodified plugs and matching outlets will reduce risk of electric shock.
- ▶ **Avoid body contact with earthed or grounded surfaces, such as pipes, radiators, ranges and refrigerators.** There is an increased risk of electric shock if your body is earthed or grounded.
- ▶ **Do not expose power tools to rain or wet conditions.** Water entering a power tool will increase the risk of electric shock.
- ▶ **Do not abuse the cord. Never use the cord for carrying, pulling or unplugging the power tool. Keep cord away from heat, oil, sharp edges or moving parts.** Damaged or entangled cords increase the risk of electric shock.
- ▶ **When operating a power tool outdoors, use an extension cord suitable for outdoor use.** Use of a cord suitable for outdoor use reduces the risk of electric shock.
- ▶ **If operating a power tool in a damp location is unavoidable, use a residual current device (RCD) protected supply.** Use of an RCD reduces the risk of electric shock.

## Personal safety

- ▶ **Stay alert, watch what you are doing and use common sense when operating a power tool. Do not use a power tool while you are tired or under the influence of drugs, alcohol or medication.** A moment of inattention while operating power tools may result in serious personal injury.
- ▶ **Use personal protective equipment. Always wear eye protection.** Protective equipment such as dust mask, non-skid safety shoes, hard hat, or hearing protection used for appropriate conditions will reduce personal injuries.
- ▶ **Prevent unintentional starting. Ensure the switch is in the off-position before connecting to power source and/or battery pack, picking up or carrying the tool.** Carrying power tools with your finger on the switch or energising power tools that have the switch on invites accidents.

- ▶ **Remove any adjusting key or wrench before turning the power tool on.** A wrench or a key left attached to a rotating part of the power tool may result in personal injury.
- ▶ **Do not overreach. Keep proper footing and balance at all times.** This enables better control of the power tool in unexpected situations.
- ▶ **Dress properly. Do not wear loose clothing or jewellery. Keep your hair, clothing and gloves away from moving parts.** Loose clothes, jewellery or long hair can be caught in moving parts.
- ▶ **If devices are provided for the connection of dust extraction and collection facilities, ensure these are connected and properly used.** Use of dust collection can reduce dust-related hazards.

#### **Power tool use and care**

- ▶ Do not force the power tool. Use the correct power tool for your application. The correct power tool will do the job better and safer at the rate for which it was designed.
- ▶ **Do not use the power tool if the switch does not turn it on and off.** Any power tool that cannot be controlled with the switch is dangerous and must be repaired.
- ▶ **Disconnect the plug from the power source and/or the battery pack from the power tool before making any adjustments, changing accessories, or storing power tools.** Such preventive safety measures reduce the risk of starting the power tool accidentally.
- ▶ **Store idle power tools out of the reach of children and do not allow persons unfamiliar with the power tool or these instructions to operate the power tool.** Power tools are dangerous in the hands of untrained users.
- ▶ **Maintain power tools. Check for misalignment or binding of moving parts, breakage of parts and any other condition that may affect the power tool's operation. If damaged, have the power tool repaired before use.** Many accidents are caused by poorly maintained power tools.
- ▶ **Keep cutting tools sharp and clean.** Properly maintained cutting tools with sharp cutting edges are less likely to bind and are easier to control.
- ▶ **Use the power tool, accessories and tool bits etc. in accordance with these instructions, taking into account the working conditions and the work to be performed.** Use of the power tool for operations different from those intended could result in a hazardous situation.

#### **Service**

- ▶ **Have your power tool serviced by a qualified repair person using only identical replacement parts.** This will ensure that the safety of the power tool is maintained.

## **2.2 Hammer safety warnings**

- ▶ **Wear ear protectors.** Exposure to noise can cause hearing loss.

- ▶ **Use auxiliary handles, if supplied with the tool.** Loss of control can cause personal injury.
- ▶ **Hold power tool by insulated gripping surfaces, when performing an operation where the cutting accessory may contact hidden wiring or its own cord.** Cutting accessory contacting a "live" wire may make exposed metal parts of the power tool "live" and could give the operator an electric shock.

### 2.3 Additional safety instructions for breakers

#### Personal safety

- ▶ Use the product only when it is in technically faultless condition.
- ▶ Never tamper with or modify the tool in any way.
- ▶ Use the auxiliary grip supplied with the tool. Loss of control can cause personal injury.
- ▶ Apply appropriate safety measures at the opposite side of the workpiece in work that involves breaking through. Parts breaking away could fall out and / or fall down causing injury to other persons.
- ▶ Always hold the power tool with both hands on the grips provided. Keep the grips clean and dry.
- ▶ Hold the power tool by the insulated gripping surfaces when performing work in which the accessory tool might come into contact with concealed wiring. If the accessory tool comes into contact with a live wire, metal parts of the power tool can also become live, resulting in an electric shock.
- ▶ Wear suitable protective glasses, a hard hat, ear protection, protective gloves and light respiratory protection while using the tool.
- ▶ Wear protective gloves also when changing the accessory tool. Touching the accessory tool presents a risk of injury (cuts or burns).
- ▶ Wear eye protection. Flying fragments present a risk of injury to the body and eyes.
- ▶ Before starting work, check the hazard class of the dust that will be produced when working. Use an industrial vacuum cleaner with an officially approved protection class in compliance with the locally applicable dust protection regulations. Dust from materials such as lead-based paint, certain types of wood and concrete/masonry/stone containing quartz, minerals or metal can be harmful to health.
- ▶ Make sure that the workplace is well ventilated and, where necessary, wear a respirator appropriate for the type of dust generated. Contact with or inhalation of the dust may cause allergic reactions and/or respiratory or other diseases to the operator or bystanders. Certain kinds of dust are classified as carcinogenic such as oak and beech dust, especially in conjunction with additives for wood conditioning (chromate, wood preservative). Material containing asbestos may be handled only by specialists.

- ▶ Take breaks between working and do physical exercises to improve the blood circulation in your fingers. Exposure to vibration during long periods of work can lead to disorders of the blood vessels and nervous system in the fingers, hands and wrists.

### **Electrical safety**

- ▶ Before beginning work, check the working area for concealed electric cables or gas and water pipes. External metal parts of the power tool may become live, presenting a risk of electric shock, if you damage an electric cable accidentally.

### **Careful handling and use of electric tools**

- ▶ Wait until the power tool stops completely before you lay it down.







### 3 Description

#### 3.1 Overview of the product

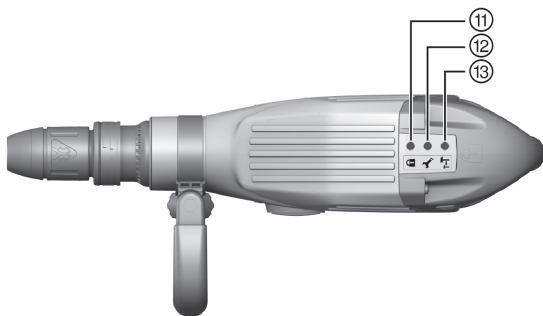
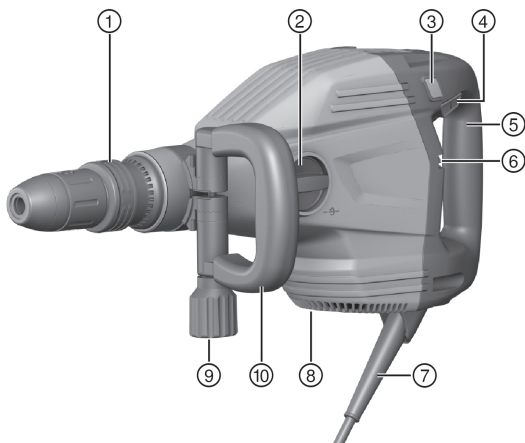

- |                                |   |
|--------------------------------|---|
| ① Chuck                        | ⑧ Air vents                             |
| ② Function selector switch     | ⑨ Knob                                  |
| ③ Power level selection switch | ⑩ Side handle                           |
| ④ On/off switch                | ⑪ Theft protection indicator (optional) |
| ⑤ Grip                         | ⑫ Service indicator                     |
| ⑥ Indicators                   | ⑬ Power level indicator                 |
| ⑦ Supply cord                  |   |

### 3.2 Intended use

The product described is an electrically powered breaker for medium-duty chiseling work. It is designed for removing and breaking up concrete, masonry and stone.

- ▶ Operation is permissible only when connected to a power source providing a voltage and frequency in compliance with the information given on the type identification plate.

### 3.3 Active Vibration Reduction (AVR)

The breaker is equipped with an Active Vibration Reduction (AVR) system, which reduces vibration significantly.

### 3.4 Service indicator

The breaker is equipped with a service indicator LED.

Status	Meaning
The service indicator lights red.	<ul style="list-style-type: none"> <li>• End of service interval – servicing is due.</li> <li>• A fault has occurred in the tool.</li> </ul>
The service indicator blinks red.	<ul style="list-style-type: none"> <li>• The overheating prevention cut-out has been activated.</li> <li>• The voltage provided by the electric supply is too high.</li> </ul>



#### Note

Bring the product to **Hilti** Service in good time. This will help to ensure that it's always ready for use.

### 3.5 Power level indicator

The breaker is equipped with a power level indicator LED.

Chiseling power can be reduced to approx. 70% by pressing the power level selector switch. The power level LED then lights up, indicating reduced power.

### 3.6 Restart interlock

The tool doesn't restart automatically when the power returns after an interruption in the supply. The on/off switch must first be released and then pressed again to restart.

### 3.7 Items supplied

Breaker, side handle, operating instructions.



#### Note

You can find other system products approved for your product at your local **Hilti** Center or online at: [www.hilti.com](http://www.hilti.com)

## 4 Technical data

### 4.1 Breaker



#### Note

For details of the rated voltage, frequency, current and input power, please refer to the power tool's country-specific type identification plate.

When powered by a generator or transformer, the generator or transformer's power output must be at least twice the rated input power shown on the rating plate of the power tool. The operating voltage of the transformer or generator must always be within +5% and -15% of the rated voltage of the power tool.

<b>Single impact energy in accordance with EPTA procedure 05/2009</b>	11.5 J
<b>Weight in accordance with EPTA procedure 01</b>	7.9 kg

### 4.2 Noise information and vibration values in accordance with EN 60745

The sound pressure and vibration values given in these instructions have been measured in accordance with a standardized test and may be used to compare one electric tool with another. They may be used for a preliminary assessment of exposure. The data given represents the main applications of the electric tool. However, if the electric tool is used for different applications, with different accessory tools, or is poorly maintained, the data may vary. This may significantly increase exposure over the total working period. An accurate estimation of exposure should also take into account the times when the tool is switched off, or when it is running but not actually being used for a job. This may significantly reduce exposure over the total working period. Identify additional safety measures to protect the operator from the effects of noise and/or vibration, for example: maintenance of the electric tool and the accessories, keeping the hands warm, organization of work patterns.

## Noise emission values

Sound (power) level ( $L_{WA}$ )	97 dB(A)
Uncertainty for the sound power level ( $K_{WA}$ )	3 dB(A)
Emission sound pressure level ( $L_{pA}$ )	86 dB(A)
Uncertainty for the sound pressure level ( $K_{pA}$ )	3 dB(A)

## Total vibration

Chiseling ( $a_{h, Cheq}$ )	6.5 m/s <sup>2</sup>
Uncertainty (K)	1.5 m/s <sup>2</sup>

## 5 Operation

### 5.1 Preparations at the workplace

#### CAUTION

**Risk of injury!** Inadvertent starting of the product.

- ▶ Unplug the supply cord before making adjustments to the power tool or before changing accessories.

Observe the safety instructions and warnings in this documentation and on the product.

### 5.2 Fitting the side handle

#### CAUTION

**Risk of injury!** Loss of control over the breaker.

- ▶ Check that the side handle is fitted correctly and tightened securely.

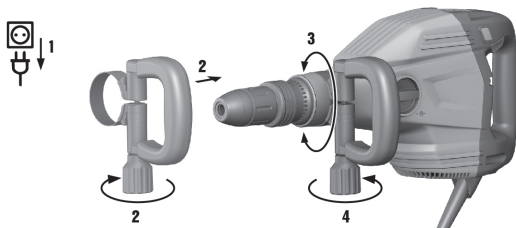

1. Slide the side handle clamping band over the chuck from the front and into the recess provided.
2. Bring the side handle into the desired position.

- Secure the side handle by turning the knob until the clamping band is tight.

### 5.3 Fitting the accessory tool



#### WARNING

**Risk of injury!** The accessory tool gets hot during use and may also have sharp edges.

- ▶ Wear protective gloves when changing the tool.



#### DANGER

**Risk of fire!** Risk of contact between the hot accessory tool and highly inflammable materials.

- ▶ Do not lay the hot accessory tool down on highly inflammable materials.



#### Note

Check the accessory tool for damage or uneven wear each time before use and replace it if necessary.



#### Note

Use only the recommended grease supplied by **Hilti**. Use of unsuitable grease may cause damage to the product.

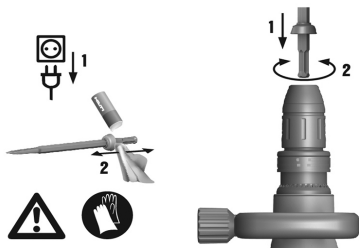

- Apply a little grease to the connection end of the accessory tool.
- Push the accessory tool into the chuck as far as it will go, turning it and applying light pressure until it engages with an audible click.
  - ◀ The product is ready for use.



#### Note

Use only the recommended grease supplied by **Hilti**. Use of unsuitable grease may cause damage to the product.

## 5.4 Removing the accessory tool



### DANGER

**Risk of fire!** Risk of contact between the hot accessory tool and highly inflammable materials.

- ▶ Do not lay the hot accessory tool down on highly inflammable materials.



### WARNING

**Risk of injury!** The tool becomes hot as a result of use.

- ▶ Wear protective gloves when changing the tool.

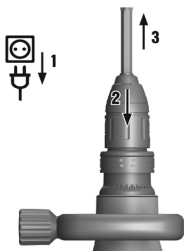

1. Pull the chuck back.
2. Remove the accessory tool.



### Note

Use only the recommended grease supplied by **Hilti**. Use of unsuitable grease may cause damage to the product.

## 5.5 Positioning the chisel



### Note

The chisel can be adjusted to 24 different positions (in 15° increments). This ensures that flat chisels and shaped chisels can always be set to the optimum working position.



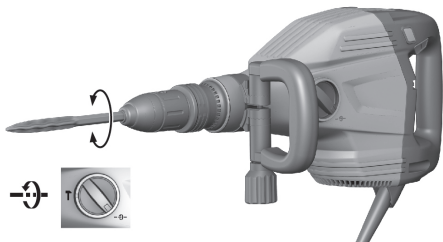

- ▶ Set the function selector switch to  and position the chisel as desired.

### 5.6 Locking the chisel

- ▶ Set the function selector switch to **T** and rotate the chisel until it engages.

### 5.7 Setting the chiseling power



#### Note

Chiseling power can be reduced to approx. 70% by pressing the power level selector switch. The power level LED then lights up, indicating reduced power.

Chiseling power can be adjusted only when the power tool is switched on and ready for use. To reselect full chiseling power, press the chiseling power level selector switch again. Switching off and then on again also causes the power tool to return to full chiseling power.

- ▶ Press the power level selector switch.

## 6 Types of work



#### WARNING

**Risk of electric shock!** Severe injury and burns can result if any attempt is made to operate the tool without an earth/ground conductor and ground fault circuit interrupter correctly connected.

- ▶ Irrespective of whether mains power or generator power is used, always make sure that an earth/ground conductor and ground fault circuit interrupter are present in the power supply and that these are correctly connected.
- ▶ Do not use the product unless these safety measures are in place and fully operational.

Observe the safety instructions and warnings in this documentation and on the product.

## 6.1 Chiseling

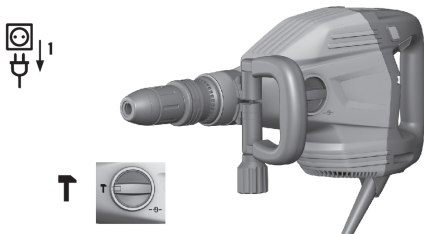

- ▶ Set the function selector switch to the **T** position.

## 7 Care and maintenance

### **WARNING**

**Danger of electric shock!** Carrying out care and maintenance while the supply cord is connected to the power outlet presents a risk of serious injuries including burns.

- ▶ Always unplug the supply cord before carrying out all care and maintenance tasks.

### **Care**

- Carefully remove stubborn dirt from the tool.
- Clean the air vents carefully with a dry brush.
- Use only a slightly damp cloth to clean the casing. Do not use cleaning agents containing silicone as they can attack the plastic parts.

### **Maintenance**

### **WARNING**

**Danger of electric shock!** Improper repairs to electrical components may lead to serious injuries including burns.

- ▶ Repairs to the electrical section of the tool or appliance may be carried out only by trained electrical specialists.

- At regular intervals, check all visible parts and the controls for signs of damage and make sure that they all function correctly.
- Do not operate the power tool if signs of damage are found or if parts malfunction. Have damage repaired immediately by **Hilti Service**.
- After cleaning and maintenance, refit all guards or protective devices and check that they function correctly.



## Note

To help ensure safe and reliable operation, use only genuine Hilti spare parts and consumables. Spare parts, consumables and accessories approved by Hilti for use with the product can be found at your local **Hilti Center** or online at: **[www.hilti.com](http://www.hilti.com)**

### 7.1 Cleaning the dust shield

- ▶ Clean the dust shield on the chuck with a dry, clean cloth at regular intervals.
- ▶ Clean the sealing lip by wiping it carefully and then grease it again lightly with **Hilti** grease.
- ▶ It is essential that the dust shield is replaced if the sealing lip is damaged.

## 8 Transport and storage

- Do not transport electric tools with accessory tools fitted.
- Always unplug the supply cord before storing an electric tool or appliance.
- Store tools and appliances in a dry place where they cannot be accessed by children or unauthorized persons.
- Check electric tools or appliances for damage after long periods of transport or storage.

## 9 Troubleshooting

If the trouble you are experiencing is not listed in this table or you are unable to remedy the problem by yourself, please contact **Hilti Service**.

### 9.1 Troubleshooting

Trouble or fault	Possible cause	Action to be taken
The breaker doesn't start.	Electronics initialization in progress (takes up to 4 seconds after plugging in).	▶ Switch the power tool off and then on again.
	The electronic restart interlock is activated after an interruption in the electric supply.	▶ Switch the power tool off and then on again.
	Interruption in the electric supply.	▶ Plug in another electric tool or appliance and check whether it works.

Trouble or fault	Possible cause	Action to be taken
The breaker doesn't start.	The generator is in sleep mode.	▶ Apply a load to the generator by connecting a second power consumer (e.g. worklight). Switch the tool off and then on again.
	The tool is faulty or servicing is due.	▶ Have the product repaired only by <b>Hilti Service</b> .
No hammering action.	The power tool is too cold.	▶ Bring the tip of the accessory tool into contact with the working surface, switch the power tool on and allow it to run. If necessary, repeat the procedure until the hammering mechanism begins to operate.
	Chuck not sufficiently greased.	▶ Inject 1-2 strokes of grease from the dispenser into the chuck. Use genuine <b>Hilti</b> grease. Then fit the accessory tool and distribute the grease in the chuck by pulling the accessory tool in and out several times.
The service indicator lights red.	The tool is faulty or servicing is due.	▶ Have the product repaired only by <b>Hilti Service</b> .
The service indicator blinks red.	The overheating prevention cut-out has been activated.	▶ Allow the tool to cool down. Clean the air vents. Running under no load is still possible.
	The voltage provided by the electric supply is too high.	▶ Use a different power outlet. Check the electric supply.

Trouble or fault	Possible cause	Action to be taken
The breaker switches itself off while running.	The overheating prevention cut-out has been activated.	▶ Allow the tool to cool down. Clean the air vents. Running under no load is still possible.
The breaker doesn't achieve full power.	Power reduction is active.	▶ Press the power level selector switch (observe the power level indicator). Unplug the power tool from the electric supply and then plug it back in.
	The extension cord is too long or its gauge is inadequate.	▶ Use an extension cord of an approved length and / or of adequate gauge.
	The voltage provided by the electric supply is too low.	▶ Connect the power tool to a different power source.
The chisel cannot be released from the chuck.	The chuck is not pulled back fully.	▶ Pull the chuck back as far as it will go and remove the insert tool.

## 10 Disposal

 Most of the materials from which **Hilti** tools and appliances are manufactured can be recycled. The materials must be correctly separated before they can be recycled. In many countries, your old tools, machines or appliances can be returned to **Hilti** for recycling. Ask **Hilti** Service or your Hilti representative for further information.



- ▶ Disposal of electric tools or appliances together with household waste is not permissible.

## 11 Manufacturer's warranty

- ▶ Please contact your local **Hilti** representative if you have questions about the warranty conditions.





**Hilti Aktiengesellschaft**  
Feldkircherstraße 100  
9494 Schaan | Liechtenstein

**TE 700-AVR (01)**

[2008]

L<sub>WA</sub> (2000/14/EG-Anhang VI) 94 dB/1pW

L<sub>WA</sub> (2000/14/EG-Anhang VI) 98 dB/1pW

2011/65/EU

2014/30/EU

2006/42/EG

2000/14/EG-Anhang VI

EN ISO 12100

EN 60745-1

EN 60745-2-6

**Paolo Luccini**

Head of BA Quality and Process Management  
Business Area Electric Tools & Accessories

Schaan, 20.04.2016

**Tasilo Deinzer**

Executive Vice President  
Business Unit Power Tools & Accessories



Hilti Corporation

LI-9494 Schaan

Tel.: +423/234 21 11

Fax: +423/234 29 65

[www.hilti.com](http://www.hilti.com)

Hilti = registered trademark of Hilti Corp., Schaan

Printed: 02.02.2017 | Doc-Nr: PUB / 5270002 / 000 / 01



20161128